



### ***smd* Series Drives**

### Modbus Communications Reference Guide

## ***About These Instructions***

This documentation applies to the use of an **smd** Series Variable Frequency Drive in a Modbus Network and should be used in conjunction with the **smd** Series Operating Instructions (Document SL03) that shipped with the drive. These documents should be read in their entirety as they contain important technical data and describe the installation and operation of the drive.

Modbus® and Modicon® are registered trademarks of Schneider Electric; <http://www.schneider-electric.com>.

For more information about the Modbus Protocol please refer to the Modicon Modbus Protocol Reference Guide; <http://www.Modbus-IDA.org>

© 2003 AC Technology Corporation

No part of this documentation may be copied or made available to third parties without the explicit written approval of AC Technology Corporation. All information given in this documentation has been carefully selected and tested for compliance with the hardware and software described. Nevertheless, discrepancies cannot be ruled out. AC Tech does not accept any responsibility nor liability for damages that may occur. Any necessary corrections will be implemented in subsequent editions.

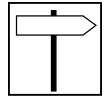

1	Safety Information.....	1
1.1	Warnings, Cautions and Notes .....	1
1.1.1	General .....	1
1.1.2	Application .....	1
1.1.3	Installation .....	1
1.1.4	Electrical Connection.....	2
1.1.5	Operation .....	2
1.2	Reference and Links .....	2
2	Introduction.....	3
2.1	RS485 Details.....	3
2.2	Electrical Installation.....	3
2.2.1	Cable Type .....	3
2.2.2	Connections and Shielding .....	3
2.2.3	Network Termination.....	4
2.3	Modbus Details.....	4
2.4	Universal Registers .....	6
3	Data Representation - Internal and External.....	7
3.1	Register Format .....	7
3.2	Data Types .....	7
3.3	<i>smd</i> Drive Registers.....	7
4	<i>smd</i> Drive Setup & Operation .....	8
4.1	Control Parameter.....	8
4.2	Serial Address .....	8
4.3	Serial Communications Parameter .....	8
4.4	Watchdog Timer .....	9
4.5	Unlocking & Locking Controls .....	10
4.6	Unlocking & Locking Programming Parameters only .....	10
4.7	Monitoring Only Operation .....	10
4.8	Normal Control Operation Sequence .....	11
4.9	Start/Stop, Speed Control and Parameter Change Operation .....	11



# Contents

5	<i>smd</i> Drive Control Registers .....	12
5.1	Abbreviations.....	13
5.2	Drive Control - Register #1.....	13
5.3	Drive Hardware Configuration - Register #22 .....	14
5.4	Drive Status - Registers #24-29.....	15
5.4.1	Reading Register #24.....	15
5.4.2	Operational Status - Register #26.....	16
5.4.3	Actual Rotational Direction - Registers #24 & 27 .....	16
5.4.4	Control Mode - Registers #24 & 27 .....	16
5.4.5	Speed Command Source - Registers #24 & 28.....	17
5.4.6	Speed Reference Status - Registers #24 & 28.....	17
5.4.7	Present Fault - Registers #24 & 29.....	17
5.4.8	Commanded Rotational Direction - Registers #24 & 29 .....	18
5.5	Motor Volts - Register #30 .....	18
5.6	Serial Speed - Register #40 .....	18
5.7	Unlock Commands - Register #48.....	18
5.8	Unlock Parameters - Register #49 .....	18
5.9	Register Version.....	18
6	<i>smd</i> Programming Parameters .....	19
6.1	Format.....	19
6.2	Parameter List.....	20
7	Quick Start Instructions .....	25
7.1	Initial Settings.....	25
7.2	Drive Control.....	26
7.3	Basic Drive Commands.....	26
7.4	Basic Drive Status.....	27



## 1 Safety Information

### 1.1 Warnings, Cautions and Notes

#### 1.1.1 General

Some parts of Lenze controllers (frequency inverters, servo inverters, DC controllers) can be live, moving and rotating. Some surfaces can be hot.

Non-authorized removal of the required cover, inappropriate use, and incorrect installation or operation creates the risk of severe injury to personnel or damage to equipment.

All operations concerning transport, installation, and commissioning as well as maintenance must be carried out by qualified, skilled personnel (IEC 364 and CENELEC HD 384 or DIN VDE 0100 and IEC report 664 or DIN VDE0110 and national regulations for the prevention of accidents must be observed).

According to this basic safety information, qualified skilled personnel are persons who are familiar with the installation, assembly, commissioning, and operation of the product and who have the qualifications necessary for their occupation.

#### 1.1.2 Application

Drive controllers are components designed for installation in electrical systems or machinery. They are not to be used as appliances. They are intended exclusively for professional and commercial purposes according to EN 61000-3-2. The documentation includes information on compliance with EN 61000-3-2.

When installing the drive controllers in machines, commissioning (i.e. the starting of operation as directed) is prohibited until it is proven that the machine complies with the regulations of the EC Directive 98/37/EC (Machinery Directive); EN 60204 must be observed.

Commissioning (i.e. starting drive as directed) is only allowed when there is compliance to the EMC Directive (89/336/EEC).

The drive controllers meet the requirements of the Low Voltage Directive 73/23/EEC. The harmonised standards of the series EN 50178/DIN VDE 0160 apply to the controllers.

**The availability of controllers is restricted according to EN 61800-3. These products can cause radio interference in residential areas. In the case of radio interference, special measures may be necessary for drive controllers.**

#### 1.1.3 Installation

Ensure proper handling and avoid excessive mechanical stress. Do not bend any components and do not change any insulation distances during transport or handling. Do not touch any electronic components and contacts. Controllers contain electrostatically sensitive components, which can easily be damaged by inappropriate handling. Do not damage or destroy any electrical components since this might endanger your health! When installing the drive ensure optimal airflow by observing all clearance distances in the drive's user manual. Do not expose the drive to excessive: vibration, temperature, humidity, sunlight, dust, pollutants, corrosive chemicals or other hazardous environments.



# Safety Information

## 1.1.4 Electrical Connection

When working on live drive controllers, applicable national regulations for the prevention of accidents (e.g. VBG 4) must be observed.

The electrical installation must be carried out in accordance with the appropriate regulations (e.g. cable cross-sections, fuses, PE connection). Additional information can be obtained from the regulatory documentation.

The regulatory documentation contains information about installation in compliance with EMC (shielding, grounding, filters and cables). These notes must also be observed for CE-marked controllers.

The manufacturer of the system or machine is responsible for compliance with the required limit values demanded by EMC legislation.

## 1.1.5 Operation

Systems including controllers must be equipped with additional monitoring and protection devices according to the corresponding standards (e.g. technical equipment, regulations for prevention of accidents, etc.). You are allowed to adapt the controller to your application as described in the documentation.



**DANGER!**

- After the controller has been disconnected from the supply voltage, do not touch the live components and power connection until the capacitors have discharged. Please observe the corresponding notes on the controller.
- Do not continuously cycle input power to the controller more than once every three minutes.
- Close all protective covers and doors during operation.



**WARNING!**

Network control permits automatic starting and stopping of the inverter drive. The system design must incorporate adequate protection to prevent personnel from accessing moving equipment while power is applied to the drive system.

Table 1: Pictographs used in these instructions

Pictograph	Signal word	Meaning	Consequences if ignored
	<b>DANGER!</b>	Warning of Hazardous Electrical Voltage.	Reference to an imminent danger that may result in death or serious personal injury if the corresponding measures are not taken.
	<b>WARNING!</b>	Impending or possible danger for persons	Death or injury
	<b>STOP!</b>	Possible damage to equipment	Damage to drive system or its surroundings
	<b>NOTE</b>	Useful tip: If observed, it will make using the drive easier	

## 1.2 Reference and Links

*smd* Series Variable Frequency Drives visit: <http://www.lenze-actech.com>

Modbus-IDA visit: <http://www.modbus-IDA.org>



## 2 Introduction

This document defines the specifics required for Modbus serial communication with a Lenze-AC Tech standard **smd** Series drive for control, status monitoring, and programming parameters. A familiarity with normal drive capabilities and operations is assumed. If this is not the case, refer to the **smd** Series Operating Instructions (SL03) for more information.

### 2.1 RS485 Details

Only standard **smd** models with an “L” as the eighth digit in the model number (ex. ESMD371L4TXA) are equipped with Modbus RS-485 capabilities. When using this feature the drive can communicate with a personal computer (PC), programmable logic controller (PLC), or other external device that utilizes Modbus RS-485 serial communication for control or monitoring. Refer to the **smd** Operating Instructions (SL03) for connection details. Figure 1 illustrates the **smd** control strip. Terminals 7 (COM), 71 (TXB) and 72 (TXA) are used for RS485 communication.

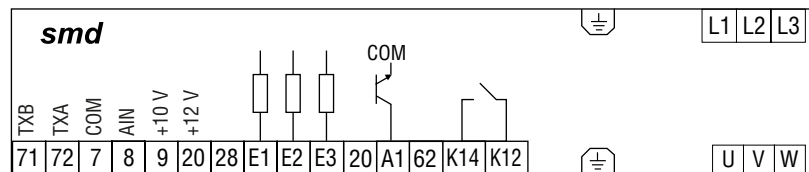

Figure 1: *smd* Control Strip

## 2.2 Electrical Installation

### 2.2.1 Cable Type

For RS485 Modbus networks, use a quality shielded twisted pair cable. The use of low quality cable will result in excess signal attenuation and data loss.

### 2.2.2 Connections and Shielding

To ensure good system noise immunity all networks cables should be correctly grounded:

- Minimum grounding recommendation: ground the network cable shield once in every cubical.
- Ideal grounding recommendation: ground the network cable on or as near to each drive as possible.
- For wiring of cable to the *smd* control terminal, the unscreened cable cores should be kept as short as possible; recommended maximum of 20mm. Ground the shield at the drive end only.
- In addition, grounding terminal 7 on the *smd* is recommended when using serial communications.

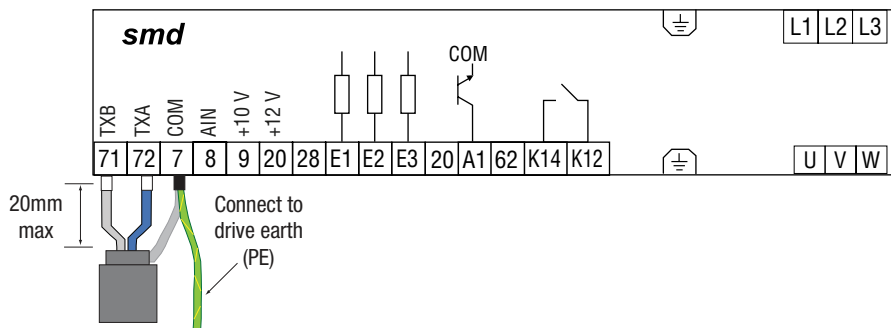

Figure 2: Connector Wiring Diagram



# Introduction

## 2.2.3 Network Termination

For an RS-485 network it is essential to install the specified termination resistors (120Ω), i.e. one at both ends of a network segment. Failure to do so will result in signals being reflected back along the cable which will cause data corruption. An external 120Ω 1/4W resistor can be connected as shown in Figure 3.

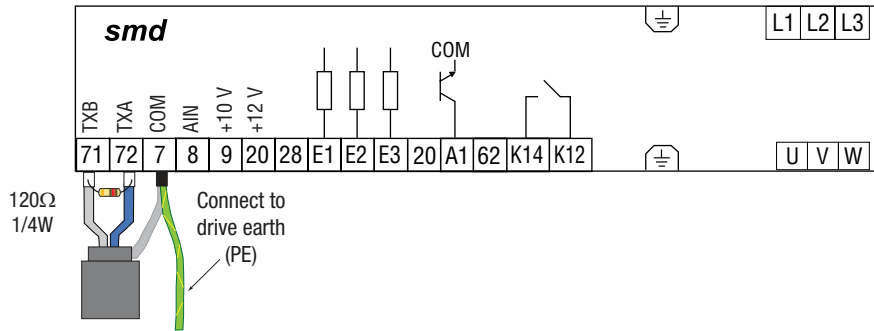
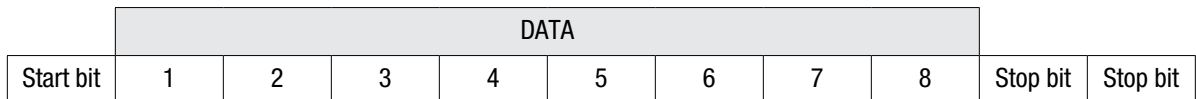

Figure 3: Network Termination Resistor

## 2.3 Modbus Details

A. **smd** Drives running the Modbus communication protocol use the RTU (Remote Terminal Unit) transmission mode and are slaves only. Therefore, the device communicating with the drives must be a Modbus Master. The baud rate is 9600. The default setting is no parity (two stop bits). There are provisions for: No parity, 1 stop bit (PV507); Odd parity, 1 stop bit; and Even parity 1 stop bit as well. The bit sequence is:



- B. At this time the **smd** drive does not support the broadcast function of the protocol.
- C. IMPORTANT NOTE: Modbus 3X and 4X Registers are numbered starting at 1. However, when transmitted to a slave over the serial link, the actual address transmitted is one less. This is because the addresses are numbered starting from 0. The **smd** register numbers are also numbered starting from 0. Therefore, **smd** register numbers always correspond exactly with the address transmitted. As a result, MODBUS REGISTER NUMBERS ARE ALWAYS ONE GREATER THAN **smd** REGISTER NUMBERS. WHENEVER THE WORDS “REGISTER #xx” APPEAR, IT SHOULD BE ASSUMED THAT THEY MEAN “**smd** REGISTER xx” and the Modbus Register number will be one larger. In some instances we may show both for clarity. For example: “Register #24 (Modbus Register #25) . . .”





D. The function codes supported by the **smd** drives are:

03 Read Holding Register (4X references). In general we can read only one register at a time. However, there are a few limited exceptions.

Exception One:

Register #24 (Modbus Register #25) Drive Status, can also be read as a group of 6 words.

Exception Two:

Parameter C99 (Software Version) is a 4-word read.

04 Read Input Register (3X references). As with function 03, we read one register at a time except where noted.

06 Preset Single Register (4X references). Write single register.

16 Preset Multiple Registers (4X references). Although the function is for multiple registers, we will accept only a single register to be written.

Note: Since we do not differentiate between 4X and 3X references, function codes 03 and 04 are treated identically.

E. Exception codes:

01 - Command rejected, Illegal function

02 - No such register

03 - Data out of range

04 - Wrong data format

06 - Slave device busy

F. The **smd** drive will most nearly conform to the Modicon® Micro 84 in capabilities. This may be of importance when configuring networks for DDE Servers.

G. Modbus® and Modicon® are registered trademarks of Schneider Electric. For more information about the Modbus Protocol please refer to the Modicon Modbus Protocol Reference Guide. Web resources: <http://www.Modbus-IDA.org> and <http://www.schneider-electric.com>.



# Introduction

## 2.4 Universal Registers

Lenze-AC Tech manufactures several drive families. Currently the QC, MC, MCH, SC, TC, **smd**, **Tmd** and SMV Series drives support Modbus based communications. Since each drive family has different parameters and size ranges, the parameter (register) definitions are in many cases quite different. In order to facilitate communication in a network with a mix of drive types, certain Lenze-AC Tech Register locations have been made universal among Lenze-AC Tech drives. While their locations are consistent, their contents may vary as defined in Table 2.

Table 2: Contents of Universal Registers

<b>smd Reg #</b>	<b>Function</b>
1	Drive Control (WRITE ONLY). Not all drives will have all control functions but when the function is available it will be at a defined bit location within Register #1. Drive Family and register Configuration Number dependent.
19	Drive Family (READ ONLY) This register is consistent among all Lenze-AC Tech drives:
	- 64 -- QC family      - 67 --      - 70 -- TC family
	- 65 -- MC family      - 68 -- MCH family      - 71 -- <i>Tmd</i> family
	- 66 -- SC family      - 69 -- <i>smd</i> family      - 72 -- SMV family
21	Drive Size (READ ONLY). Code to identify Power (HP/KW) and Line Voltage of the drive. Family dependent. For the <i>smd</i> series it always reads zero.
24	Drive Status (READ ONLY). Various operational variables.
48	Unlock Control (WRITE ONLY).
49	Unlock Writing of registers (WRITE ONLY).
50	Parameter Configuration Number (READ ONLY).



## 3 Data Representation - Internal and External

### 3.1 Register Format

All registers are 16 bits. The data within these registers can take on the following forms:

- Individual bit commands (16 per register).  
Example: Register #1 (Modbus Register #2).
- Individual bit flags (16 per register).  
Example: Register #22.
- A chain of two 8 bit unsigned integers.
- A 16 bit unsigned integer.

This unsigned integer could in turn represent many different types of data with various scaling rules and units, which are defined by the DATA TYPE of the register.

### 3.2 Data Types

Data passed in registers across the Modbus communications link are always in INTERNAL units. The drive itself may show the information in alternate DISPLAYED units. For Example: drive speeds are always stored internally as tenths of a Hz but the drive may display that speed in whole Hz by dropping the tenth using programmed conversion factors. Table 3 lists examples of the internal units used on the **smd** series.

Table 3: **smd** Series Internal Units

Type	Unit	Example
SPEED	.1Hz	100Hz = 1000
TIME	.1Sec	30.0 Sec = 300

### 3.3 **smd** Drive Registers

Registers #0 through #50:  
Registers #51 through #255

(Modbus Registers #1 to #51) Reserved for configuration and control  
(Modbus Registers #52 to #256) Reserved for the drives' programming mode parameters. Programming Mode Parameters are the parameters that can be accessed from the local keypad on the drive.

The entries in Table 6 are based on **smd** Drive Software # 1.51 (Parameter Configuration = 400) and Drive SW 2.00 and 2.01 (Parameter Configuration 507). If a later revision of software were to change register definitions, drive operation could be seriously affected. This will be identified for a given drive by examining Register #50 (Parameter Configuration Number). The number displayed at power up on drive display can also identify it. If it is not 400 or 507, writing to any register on the drive MUST NOT BE ATTEMPTED unless your Controller has been setup to support the new configuration.

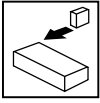

# Drive Setup & Operation

## 4 *smd* Drive Setup & Operation

### 4.1 Control Parameter

In order to communicate using Modbus protocol, the *smd* Control Source Setpoint (parameter #C01) must be set to one of the selections listed in Table 4.

Table 4: Control Source Setpoint C01 (Register 51)

Setting	Source			Description
	Program (Monitoring)	Control (Start/Stop, Direction)	Speed (Source)	
8	Modbus	Terminal	Analog Input	Drive is controlled via terminal programming and is monitored via Modbus interface or keypad. The default speed source is the analog input.
9	Modbus	Terminal	c40	Drive is controlled via terminal programming and is monitored via Modbus interface or keypad. The default speed source is c40.
10	Modbus	Modbus	Analog Input	Drive is controlled via serial interface and is monitored via Modbus interface or keypad. The default speed source is the analog input.
11	Modbus	Modbus	c40	Drive is controlled via serial interface and is monitored via Modbus interface or keypad. The default speed source is c40

### 4.2 Serial Address

The *smd* drive has a serial address parameter that must be programmed prior to attempting to operate the serial interface. Set Parameter C09 (Network Address) to a valid address (1-247).



#### Tip

Most Modbus devices ship with a default address of 1. As such, it is recommended to **not** use address 1 in order to avoid duplicate address conflicts when replacing devices.

### 4.3 Serial Communications Parameter

Lenze-AC Tech drives have a Serial Communications Parameter that governs the operation of the serial link. On *smd* drives this is c25, Serial Baud Rate {Register #95 (PC400) or #103 (PC507)}. Parameter C01 Control Source Setpoint must first be set to a value of 8-11. Table 5a lists the selections for *smd* Parameter c25, Serial Baud Rate. Table 5b lists the selections for the controller's reaction to serial timeout (n22).

Tables 5a & 5b: Serial Communications

Setting	Description
0	9600, 8, N, 2
1	9600, 8, N, 1
2	9600, 8, E, 1
3	9600, 8, O, 1

Setting	Description
0	Not active
1	Inhibit
2	Quick Stop
3	Trip Fault FC3

The Serial Communications Parameter (c25) must be appropriately programmed prior to attempting to communicate with the drive. The timeout period is programmed in Parameter n23, Serial Fault Time.

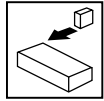

## 4.4 Watchdog Timer

The *smd* drive is equipped with a Serial Link “Watchdog Timer”. If the Modbus Master wishes to control the drive (start, stop, forward, reverse, etc.) it must first “Unlock Controls” (section 4.4). If the Watchdog Timer is enabled and controls have been unlocked, the Master **MUST PERIODICALLY COMMUNICATE** with the drive or the timer will timeout. Communications should typically be done at less than 1/2 the interval specified in n23, Serial Fault Time.

The Watchdog Timer does not operate unless Controls have been UNLOCKED via Register #48, or parameters writing has been unlocked via Register #49. In case of unlocking parameters only, watchdog timer will disable write permission but will not stop the drive.

The Watchdog Timer is setup using parameters n22 (Serial Timeout Action) and n23 (Serial Fault Time).

Selection of n22 determines the *smd* drive's reaction to serial timeout:

n22 = 0:	Not Active	The Watchdog Timer is disabled
n22 = 1:	Controller Inhibit	If the drive doesn't receive valid communication for period longer than time specified in parameter n23, it will COAST to a STOP and status display (c61) will show inhibit state 'Inh'.
n22 = 2:	Quick Stop	If drive doesn't receive valid communication for period longer than time specified in parameter n23, it will RAMP to a STOP and status display (c61) will show inhibit state 'Stp'.
n22 = 3:	Trip Fault FC3	If drive doesn't receive valid communication for period longer than time specified in parameter n23, it will TRIP with an 'FC3' fault.

The setting of Parameter n23, Serial Fault Time, sets the serial timeout length in milliseconds. The valid range is 50 - 65535 ms and the default setting is 50ms.



### NOTE - Trip Prevention

To prevent erroneous timeout trips, make sure the time set in parameter n23 is appropriate for the particular network. The default value of 50ms may be too restrictive.



### WARNING

Disabling the Watchdog Timer may cause injury to personnel and/or damage to equipment. The Watchdog Timer should only be disabled during configuration or diagnosis to prevent nuisance timeout trips.

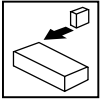

## Drive Setup & Operation

### 4.5 Unlocking & Locking Controls

Registers #48 and #1 are used in Unlocking and Locking Controls.

- A write to Register #48 (Unlock Controls) with a value of 0 will unlock controls. This enables the writing of Register #1 – the Drive Control Register and register #40 (keypad speed command).

Note: C01 must be set to either 10 or 11 in order to unlock serial control.

- If Register #48 (Unlock Controls) is written with a value that is the Drive's Programming Password, C94, then in addition to Register #1 (Drive Control), writing to all other writeable registers is enabled (e.g.: parameter C37 -- Preset Speed #1). The factory default password for **smd** series drives is 0.
- Once Register #48 (Unlock Controls) has been written, Controls are unlocked until Register #1 bit 1 (Lock Bit) has been written, Parameter C01 is changed to a value different than 10 or 11, the drive is powered down or a serial timeout occurs.
- Writing to Register #1 (Drive Control) with bit 1 set will Lock both Controls and Parameters (prevents writing to any register).
- When LOCK is asserted, the drive drops out of SERIAL control. After receiving the WRITE message when serial control is locked, the drive will return exception code 01.
- Even though drive might be locked, and thus parameters and control cannot be written, parameters and status can always be read. Refer to section 4.7, *Monitoring Only Operation*.

### 4.6 Unlocking & Locking Programming Parameters only

Registers #49 and #1 are used in Unlocking and Locking Programming Parameters.

- Writing to any writeable register other than #1 can be enabled by writing the Drive's Programming Password (C94) to Register #49 (Unlock Parameters). This would be done when Drive Control (start, stop, etc.) is not required.
- The Factory Default password is 0.
- Once Register #49 (Unlock Parameters) has been written, the writing of parameter registers is unlocked until Register #1 bit 1 (Lock Bit) has been set or the drive experiences a serial timeout.

### 4.7 Monitoring Only Operation

1. Power up drive.
2. Set parameter C01 (Control Source Setpoint) to selection 8 or 9.
3. Simply read **smd** Register #24 (Modbus Register #25) or any other readable register.
4. No unlocking or watchdog issues apply for monitoring.

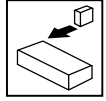

## 4.8 Normal Control Operation Sequence

1. Power up drive.
2. Set parameter C01 (Control Source Setpoint) to selection 10 or 11.
3. Close terminal 28.
4. Unlock control by writing a zero to Register #48.
5. Control drive operation via various commands to Register #1 (Start, Stop, Reverse direction, etc.).
6. Set the network speed reference by setting bit 8 of Register #1. The drive must be in "SERIAL SPEED REFERENCE" (Register #1, Drive Control) in order to control speed via Register #40.
7. Control Drive Speed by writing the Speed Commands to Register #40 (Serial Speed Command).
8. If serial timeout is activated ( $n22 = 1, 2$  or  $3$ ), keep it from timing out by assuring that repeated reads of drive status (Register #24, 6 registers) are performed at reasonable intervals smaller than the time set in parameter  $n23$ .
9. Lock Control when drive operations are complete by writing a 2 to Register #1. (assert bit 1 of Register #1).

## 4.9 Start/Stop, Speed Control and Parameter Change Operation

The typical sequence for a Start/Stop, Speed Control or Parameter Change operation is listed herein.

1. Power up drive.
2. Set parameter C01 (Control Source Setpoint) to selection 10 or 11.
3. Close terminal 28.
4. Unlock Controls and Parameters by writing the current programming password (default 0) to Register #48.
5. Control Drive Operation via various commands to Register #1 (Start, Stop, Reverse direction, etc.).
6. Set the network speed reference by setting bit 8 of Register #1. The drive must be in "SERIAL SPEED REFERENCE" (Register #1, Drive Control) in order to control speed via Register #40.
7. Control Drive Speed by writing the Speed Commands to Register #40 (Serial Speed Command).
8. Change the programming parameters (e.g., change the acceleration rate by writing new acceleration rate to register #61)
9. If serial timeout is activated ( $n22 = 1, 2$  or  $3$ ), keep it from timing out by assuring that repeated reads of drive status (Register #24, 6 registers) are performed at reasonable intervals smaller than the time set in parameter  $n23$ .
10. Lock Controls and Parameters when drive operations are complete by writing a 2 to Register #1 (assert bit 1 of Register 1).

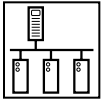

# Drive Control & Communication

## 5 *smd* Drive Control Registers

Table 6 describes the *smd* Drive Control Registers in ascending order of *smd* Register #. The HEX representation is given in parenthesis next to the *smd* Register # in the left-most column.

Table 6: *smd* Drive Control Registers

<i>smd</i> # (HEX representation)	REGISTER NAME	R/W/RS	MESSAGE								MIN	MAX	UNITS	[NOTE] or Section
1 (01)	Drive Control	W	SA	06	00	01	DH	DL	CRCH	CRCL	Refer to Section 5.2			[1]
		RS	SA	06	00	01	DH	DL	CRCH	CRCL				
19 (13)	Drive Family	R	SA	03	00	13	00	01	CRCH	CRCL	Refer to Section 5.2			[2]
		RS	SA	03	02	00	45	CRCH	CRCL					
21 (15)	Drive Size	R	SA	03	00	15	00	01	CRCH	CRCL	Refer to Section 5.2			[3]
		RS	SA	03	02	00	00	CRCH	CRCL					
22 (16)	Drive H/W	R	SA	03	00	16	00	01	CRCH	CRCL	Refer to Section 5.3			
		RS	SA	03	02	DH	DL	CRCH	CRCL					
24 (18)	Drive Status (6 register read) (reg. #24 to 29)	R	SA	03	00	18	00	06	CRCH	CRCL	Refer to Section 5.4			
		RS	SA	03	0C	D1H	D1L	D2H	D2L					
						D3H	D3L	D4H	D4L					
						D5H	D5L	D6H	D6L					
24 (18)	Command Speed	R	SA	03	00	18	00	01	CRCH	CRCL	0	2400	0.1 Hz	[4a]
		RS	SA	03	02	DH	DL	CRCH	CRCL					
25 (19)	Actual Speed	R	SA	03	00	19	00	01	CRCH	CRCL	0	2400	0.1 Hz	[4b]
		RS	SA	03	02	DH	DL	CRCH	CRCL					
26 (1A)	Load (DH) / Status (DL)	R	SA	03	00	1A	00	01	CRCH	CRCL	Refer to Section 5.4.2			[4c]
		RS	SA	03	02	DH	DL	CRCH	CRCL					
27 (1B)	Act. Direction (DH)/ Control Mode (DL)	R	SA	03	00	1B	00	01	CRCH	CRCL	Refer to Section 5.4.3/4			
		RS	SA	03	02	DH	DL	CRCH	CRCL					
28 (1C)	Speed Source (DH)/ Speed Reference (DL)	R	SA	03	00	1C	00	01	CRCH	CRCL	Refer to Section 5.4.5/6			
		RS	SA	03	02	DH	DL	CRCH	CRCL					
29 (1D)	Fault (DH)/ Commanded Direction (DL)	R	SA	03	00	1D	00	01	CRCH	CRCL	Refer to Section 5.4.7/8			[4d]
		RS	SA	03	02	DH	DL	CRCH	CRCL					
30 (1E)	Motor Voltage	R	SA	03	00	1E	00	01	CRCH	CRCL	0	250	1%	5.5
		RS	SA	03	02	DH	DL	CRCH	CRCL					
40 (28)	Serial Speed Command	R	SA	03	00	28	00	01	CRCH	CRCL	C10 Min Freq.	C11 Max Freq.	0.1 Hz	5.6
		RS	SA	03	02	DH	DL	CRCH	CRCL					
		W	SA	06	00	28	DH	DL	CRCH	CRCL				
		RS	SA	06	00	28	DH	DL	CRCH	CRCL				
48 (30)	Unlock Commands	W	SA	06	00	30	DH	DL	CRCH	CRCL	0	999	None	5.7
		RS	SA	06	00	30	DH	DL	CRCH	CRCL				
49 (31)	Unlock Parameters	W	SA	06	00	31	DH	DL	CRCH	CRCL	0	999	None	5.8
		RS	SA	06	00	31	DH	DL	CRCH	CRCL				
50 (32)	Register Version	R	SA	03	00	32	00	01	CRCH	CRCL	0	65535	None	5.9
		RS	SA	03	02	DH	DL	CRCH	CRCL					



# Drive Control & Communication

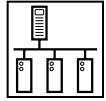

## 5.1 Abbreviations

Table 7 lists the abbreviations used in Table 6 **smd** Drive Control Registers:

Table 7: Abbreviations

Abbreviation	Description
R	Read
W	Write
RS	Response
SA	Slave Address (typically 01 through F7 hex)
CRCH	Cyclic Redundancy Check High byte
CRCL	Cyclic Redundancy Check Low byte
DH	Data High byte
DL	Data Low byte
<b>smd#</b>	<b>smd</b> Register # (Modbus Register numbers are 1 larger)

## 5.2 Drive Control - Register #1

Table 8 illustrates the Data High Byte and Data Low Byte format of Register #1, Drive Control.

Table 8: Drive Control - Register #1

<b>Data Low Byte</b>	0	UPDATE BUFFERS
	1	LOCK SECURITY
	2	STOP DRIVE (COAST TO STOP)
	3	START DRIVE
	4	UNUSED
	5	UNUSED
	6	SET REVERSE
	7	SET FORWARD
<b>Data High Byte</b>	8	SERIAL SPEED REFERENCE
	9	LOCAL SPEED REFERENCE
	10	
	11	
	12	
	13	
	14	
	15	

The appropriate bit is set to 1. For example, to stop the drive bit two is set (send 0004H). To start the drive send 0008H. Setting update buffers bit, enables to start the drive using downloaded data. Locking security disables the serial drive control, the communications watchdog timer and prevents any further writing to control or parameter registers.

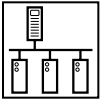

## Drive Control & Communication



### NOTE 1 - Drive Control

- During each write to Register #1 only one bit should be set in the drive control word.
- If more than 1 bit is set, the drive responds to stop bit only.
- If stop bit is not set, but more than 1 bit is set, drive responds with exception 04.



### NOTE 2 - Drive Family

- The QC and DL Series drives return 64 (40H)
- The MC Series drives return 65 (41H)
- The SC Series drives return 66 (42H)
- The MCH Series drives return 68 (44H)
- The *smd* Series drives return 69 (45H)
- The TC Series drives return 70 (46H)
- The *tmd* Series drives return 71 (47H)
- The SMV Series drives return 72 (48H)



### NOTE 3 - Drive Size

On *smd* series drives this register always read zero

## 5.3 Drive Hardware Configuration - Register #22

Table 9 lists the *smd* Drive Hardware Configuration, Register #22. Bits 4 - 15 are not used at this time.

Table 9: Register 22 - Drive Hardware Configuration

BIT #	STATE	MEANING
0	1	Reserved
	0	Reserved
1	1	Reserved
	0	Reserved
2	1	OEM defaults present
	0	No OEM defaults
3	1	User data on EPM is compatible only
	0	Either the parameter version of the EPM matches the current software or the EPM is not compatible. If incompatible then one of the following faults are responsible: CF (control fault), cF (incompatibility fault) or GF (data fault)

Bit 3 = 1: the USER data on the EPM is compatible only. The data on the EPM is valid and usable by the drive but the parameter version of the data does not match the parameter version that the drive is currently using. Therefore the user will not be able to edit any of the data on the EPM until they perform a TRANSLATE with P48.

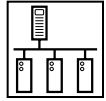

## 5.4 Drive Status - Registers #24-29

### 5.4.1 Reading Register #24

When reading register #24, the group of words requested can be either 1 or 6. This is an exception to the rule of being able to read only one register at a time. If 6 words are requested at register #24, the following will be returned:

Table 10: 6 Register read at #24

Parameter	Data Byte
Command Speed	D1H D1L
Actual Speed	D2H D2L
Load	D3H
Operation Status	D3L
Rotational Direction	D4H
Control Mode	D4L
Speed Command Source	D5H
Speed Reference Status	D5L
Present Fault	D6H
Command Rotation	D6L



#### **NOTE 4a - Command Speed (Register #24 Bytes D1H and D1L or Register #24)**

- In tenths of a Hz
- Most significant byte is first, followed by Least significant
- Example: 02 01 in hex converts to 51.3Hz in decimal (assumed 1 decimal place).



#### **NOTE 4b - Actual Speed (Register #24 Bytes D2H and D2L or Register #25)**

- In tenths of a Hz
- Most significant byte is first, followed by Least significant



#### **NOTE 4c - Load (Register #24 Byte D3H or Register #26 DH)**

- In percent of full load
- Example: 64 (one byte in hex) ==> 100 in decimal ==> 100% (drive load).

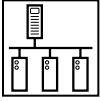

# Drive Control & Communication

## 5.4.2 Operational Status - Register #26

Table 11 lists the Operational Status (Register #24 byte D3L or Register #26 DL)

Table 11: Operational Status

Bit	Parameter
0	FAULT LOCKOUT
1	FAULT
2	START PENDING
3	STOP
4	DC BRAKE
5	RUN AT 0Hz
6	RUN
7	ACCEL
8	DECEL
9	CURRENT LIMIT
10	DECEL OVERRIDE
11	LOWER TRANSISTORS SWITCHING ON
12	OFF
13	INHIBIT

## 5.4.3 Actual Rotational Direction - Registers #24 & 27

Table 12 lists the Actual Rotational Direction (Register #24 byte D4H or Register #27 DH).

Table 12: Actual Rotational Direction

Setting	Direction
0	FORWARD
1	REVERSE

## 5.4.4 Control Mode - Registers #24 & 27

Table 13 lists the Control Mode (Register #24 byte D4L or Register #27 DL).

Table 13: Control Mode

Control Mode	Speed Source	Control Source	Program Source
0	Analog	Terminal	Keypad
1	c40	Terminal	Keypad
2	Analog	Terminal	LECOM
3	LECOM	LECOM	LECOM
4	Analog	Terminal	Remote Keypad
5	c40	Terminal	Remote Keypad
6	Analog	Remote Keypad	Remote Keypad
7	c40	Remote Keypad	Remote Keypad
8	Analog	Terminal	Modbus
9	c40	Terminal	Modbus
10	Analog	Modbus	Modbus
11	c40	Modbus	Modbus

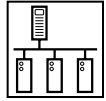

## 5.4.5 Speed Command Source - Registers #24 & 28

Table 14 lists the Speed Command Source (Register #24 byte D5H or Register #28 DH).

Table 14: Speed Command Source

Setting	Source
0	ANALOG FREQ.
1	PRESET c40
2	PRESET 1
3	PRESET 2
4	PRESET 3
5	MOP SPEED
6	SERIAL SPEED

## 5.4.6 Speed Reference Status - Registers #24 & 28

Table 15 lists the Speed Reference Status (Register #24 byte D5L or Register #28 DL).

Table 15: Speed Reference

Setting	Status
0	SERIAL SPEED REFERENCE
1	LOCAL SPEED REFERENCE

## 5.4.7 Present Fault - Registers #24 & 29

Table 16 lists the Present Fault (Register #24 byte D6H of Register #29 DH)

Table 16: Present Fault

Setting	Fault	Display	Setting	Fault	Display
0	NO FAULT		14	INTERNAL FAULT 5	F5
1	OUTPUT (TRANSISTOR) FAULT	OC1	15	INTERNAL FAULT 6	F6
2	HIGH DRIVE TEMPERATURE	OH	16	INTERNAL FAULT 7	F7
3	HIGH DC BUS VOLTAGE	OU	17	INTERNAL FAULT 8	F8
4	LOW DC BUS VOLTAGE	LU	18	INTERNAL FAULT 9	F9
5	THERMAL OVERLOAD	OC6	19	INTERNAL FAULT o	Fo
6	CONTROL FAULT	CF	20	SINGLE PHASE FAULT	SF
7	EXTERNAL FAULT	EEr	21	INCOMPATIBILITY FAULT	cF
8	SERIAL COMMUNICATION FAILURE	FC5	22	DYNAMIC BRAKE OVERHEATED	dF
9	START ERROR	LC	23	REMOTE KEYPAD FAULT	JF
10	INTERNAL FAULT 1 (EPM)	F1	24	COMMUNICATION FAULT	FC3
11	INTERNAL FAULT 2	F2	25	EARTH FAULT	OC2
12	INTERNAL FAULT 3	F3	26	CONFIGURATION FAULT	CFG
13	INTERNAL FAULT 4	F4			

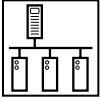

## Drive Control & Communication

### 5.4.8 Commanded Rotational Direction - Registers #24 & 29

Table 17 lists the Commanded Rotational Direction (Register #24 byte D6L or Register #29 DL)

Table 17: Commanded Rotational Direction

Setting	Direction
0	FORWARD
1	REVERSE

### 5.5 Motor Volts - Register #30

Output Voltage to the motor expressed as a percentage of nominal drive voltage.

### 5.6 Serial Speed - Register #40

This register enables the user to set the serial speed to desired value.

- In tenths of a Hz
- Most significant byte is first, followed by Least significant
- CONTROL OF THE DRIVE SPEED VIA THE SERIAL LINK IS NORMALLY DONE USING THIS PARAMETER. This register can be written only after enabling parameter writes.
- To use this register, SPEED REFERENCE must be set to SERIAL SPEED REFERENCE by setting bit 8 in control register #1.

### 5.7 Unlock Commands - Register #48

Register #48 (Unlock Commands) unlocks commands by using 0000 for the password. If the correct Programming mode password (C94) is entered then the appropriate programming parameters can also be accessed (refer to the full parameter protocol specification if access to programming parameters is required).

### 5.8 Unlock Parameters - Register #49

Register #49 (Unlock Parameters) unlocks programming parameters for writing when the proper Programming Password (C94) is entered. Whenever a parameter writing session (where #49 was activated) is to be ended, register #1 bit 1 (Lock Security) must be asserted. This disables the watchdog and prevents further write access to Parameter Registers.

### 5.9 Register Version

Register Version is the number to identify if current version of software has any register changes relative to previous versions: a register has been added or deleted, a register's min/max limits have changed, a register's function has been changed, or a register's default value has been changed. Generally it is the programming parameters that are changed. Typically the Control Registers (*smd* Register #1 through #50) are quite stable.

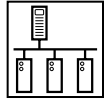

## 6 *smd* Programming Parameters

### 6.1 Format



#### NOTE - Attention

Parameter list presented in Section 6.2 is valid only for *smd* parameter version 400 and 507. For revisions, refer to appropriate *smd* Manual.

Abbreviations:

SA (1byte) Drive Address (1-247)  
 RA (1byte) Register Address  
 CRCH Cyclic Redundancy Check High byte  
 CRCL Cyclic Redundancy Check Low byte

READING:

Message structure for reading 1 word: (most of parameters)

Request: SA 03 00 RA 00 01 CRCH CRCL  
 Response: SA 03 02 DH DL CRCH CRCL

Message structure for reading 4 word: (Parameter C99 Software Version)

Request: SA 03 00 RA 00 04 CRCH CRCL  
 Response: SA 03 08 D1H D1L D2H D2L D3H D3L D4H D4L CRCH CRCL

WRITING:

Message structure for writing 1 word: (all parameters)

Request: SA 06 00 RA DH DL CRCH CRCL  
 Response: SA 06 00 RA DH DL CRCH CRCL

#### LEGEND for Parameter List

1st Column: **Parameter No.** <sup>1</sup> = Drive's programming code number

4th Column: **Range of Adjustment** <sup>2</sup> = Selections in bold are for *smd* models with PV507 only.

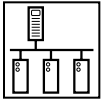

# Drive Control & Communication

## 6.2 Parameter List

Parameter No. <sup>1</sup>	smd Register # (hexadecimal representation)		Parameter Name	Range of Adjustment <sup>2</sup> Modbus value (decimal value)	Factory Default																																							
	PV400	PV507																																										
C01	51 (33H)	51 (33H)	Setpoint and Control Source	<table border="0"> <tr> <td><u>Speed</u></td> <td><u>Control</u></td> <td><u>Program</u></td> </tr> <tr> <td>0 Analog</td> <td>Terminal</td> <td>Keypad</td> </tr> <tr> <td>1 c40</td> <td>Terminal</td> <td>Keypad</td> </tr> <tr> <td>2 Analog</td> <td>Terminal</td> <td>LECOM</td> </tr> <tr> <td>3 LECOM</td> <td>LECOM</td> <td>LECOM</td> </tr> <tr> <td>4 Analog</td> <td>Terminal</td> <td>Remote Keypad</td> </tr> <tr> <td>5 c40</td> <td>Terminal</td> <td>Remote Keypad</td> </tr> <tr> <td>6 Analog</td> <td>Remote Keypad</td> <td>Remote Keypad</td> </tr> <tr> <td>7 c40</td> <td>Remote Keypad</td> <td>Remote Keypad</td> </tr> <tr> <td>8 Analog</td> <td>Terminal</td> <td>Modbus</td> </tr> <tr> <td>9 c40</td> <td>Terminal</td> <td>Modbus</td> </tr> <tr> <td>10 Analog</td> <td>Modbus</td> <td>Modbus</td> </tr> <tr> <td>11 c40</td> <td>Modbus</td> <td>Modbus</td> </tr> </table>	<u>Speed</u>	<u>Control</u>	<u>Program</u>	0 Analog	Terminal	Keypad	1 c40	Terminal	Keypad	2 Analog	Terminal	LECOM	3 LECOM	LECOM	LECOM	4 Analog	Terminal	Remote Keypad	5 c40	Terminal	Remote Keypad	6 Analog	Remote Keypad	Remote Keypad	7 c40	Remote Keypad	Remote Keypad	8 Analog	Terminal	Modbus	9 c40	Terminal	Modbus	10 Analog	Modbus	Modbus	11 c40	Modbus	Modbus	0
<u>Speed</u>	<u>Control</u>	<u>Program</u>																																										
0 Analog	Terminal	Keypad																																										
1 c40	Terminal	Keypad																																										
2 Analog	Terminal	LECOM																																										
3 LECOM	LECOM	LECOM																																										
4 Analog	Terminal	Remote Keypad																																										
5 c40	Terminal	Remote Keypad																																										
6 Analog	Remote Keypad	Remote Keypad																																										
7 c40	Remote Keypad	Remote Keypad																																										
8 Analog	Terminal	Modbus																																										
9 c40	Terminal	Modbus																																										
10 Analog	Modbus	Modbus																																										
11 c40	Modbus	Modbus																																										
C02	52 (34H)	52 (34H)	Load Lenze setting	0 No action/loading complete 1 Load 50Hz Defaults <b>2 Load 60Hz Defaults</b> <b>3 Load OEM Defaults</b> <b>4 Translate compatible EPM</b> NOTE: Drive must be in OFF or Inhibit state to change	0																																							
CE1 CE2 CE3	53 (35H) 54 (36H) 55 (37H)	53 (35H) 54 (36H) 55 (37H)	Configuration Digital Inputs E1, E2, E3	1 Activate fixed setpoint 1 (JOG1) 2 Activate fixed setpoint 2 (JOG2) 3 DC Braking (DCB) 4 Direction of Rotation 5 Quick Stop 6 CW Rotation 7 CCW Rotation 8 UP 9 DOWN 10 TRIP set 11 TRIP reset <b>12 Accel/decel 2</b> <b>13 Deactivate PI</b> <b>14 Activate fixed PI setpoint 1</b> <b>15 Activate fixed PI setpoint 2</b>	CE1 = 1 CE2 = 4 CE3 = 3																																							

1 = The drive's programming code number; 2 = Selections in **bold** are for *smd* models with PV507 only.



# Drive Control & Communication

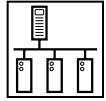

Parameter No. <sup>1</sup>	smd Register # (hexadecimal representation)		Parameter Name	Range of Adjustment <sup>2</sup> Modbus value (decimal value)	Factory Default
	PV400	PV507			
C08	57 (39H)	57 (39H)	Configuration Relay Output	0 Ready 1 Fault 2 Motor is running 3 Motor is running - CW rotation 4 Motor is running - CCW rotation 5 Output frequency = 0Hz 6 Frequency setpoint reached 7 Threshold (C17) exceeded 8 Current limit reached <b>9 Feedback within min/max alarm range</b> <b>10 Feedback outside min/max alarm range</b>	1
C09	58 (3AH)	58 (3AH)	Network Address	1 - 247	1
C10	59 (3BH)	59 (3BH)	Minimum Output Freq.	0 - 2400 (0.0 - 240 Hz)	0.0 Hz
C11	60 (3CH)	60 (3CH)	Minimum Output Freq.	75 - 2400 (7.5 - 240 Hz)	50.0 Hz
C12	61 (3DH)	61 (3DH)	Acceleration Time	0 - 9990 (0.0 - 999 sec)	5.0 sec
C13	62 (3EH)	62 (3EH)	Deceleration Time	0 - 9990 (0.0 - 999 sec)	5.0 sec
C14	63 (3FH)	63 (3FH)	Operating Mode	0 Linear with Auto Boost 1 Square Law with Auto Boost 2 Linear with Constant $V_{min}$ Boost 3 Square Law with Constant $V_{min}$ Boost	2
C15	64 (40H)	64 (40H)	V/f Reference Point	250 - 9990 (25.0 - 999 Hz)	50.0 Hz
C16	65 (41H)	65 (41H)	$V_{min}$ Boost	0 - 400 (0.0 - 40.0%)	4.0%
C17	66 (42H)	66 (42H)	Frequency Threshold	0 - 2400 (0.0 - 240 Hz)	0.0 Hz
C18	67 (43H)	67 (43H)	Chopper Frequency	0 4kHz 1 6kHz 2 8kHz 3 10kHz	2
C21	68 (44H)	68 (44H)	Slip Compensation	0 - 400 (0.0 - 40.0%)	0.0%
C22	69 (45H)	69 (45H)	Current Limit	30 - 150%	150%
C24	70 (46H)	70 (46H)	Accel Boost	0 - 200 (0.0 - 20.0%)	0.0%
C31		71 (47H)	Analog Input Deadband	0 Deadband Enabled 1 Deadband Disabled	0
C34	71 (47H)	72 (48H)	Configuration Analog Input	0 0...10V 1 0...5V 2 0...20mA 3 4...20mA <b>4 4...20mA Monitored</b>	0
C36	72 (48H)	73 (49H)	Voltage (DCB) DC Injection Brake	0 - 500 (0.0 - 50.0%)	4.0%
C37	73 (49H)	74 (4AH)	Fixed Setpoint 1 (JOG1)	0 - 9990 (0.0 - 999)	20.0 Hz

1 = The drive's programming code number; 2 = Selections in **bold** are for **smd** models with PV507 only.

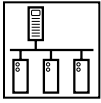

## Drive Control & Communication

Parameter No. <sup>1</sup>	smd Register # (hexadecimal representation)		Parameter Name	Range of Adjustment <sup>2</sup> Modbus value (decimal value)	Factory Default
	PV400	PV507			
C38	74 (4AH)	75 (4BH)	Fixed Setpoint 2 (JOG2)	0 - 9990 (0.0 - 999)	30.0 Hz
C39	75 (4BH)	76 (4CH)	Fixed Setpoint 3 (JOG3)	0 - 9990 (0.0 - 999)	40.0 Hz
C46	78 (4EH)	79 (4FH)	Frequency Setpoint	0 - 2400 (0.0 - 240 Hz)	Read Only
C50	79 (4FH)	80 (50H)	Output Frequency	0 - 2400 (0.0 - 240 Hz)	Read Only
C52	80 (50H)	82 (52H)	Motor Voltage	0 - 255%	Read Only
C53	81 (51H)	83 (53H)	DC Bus Voltage	0 - 255%	Read Only
C54	82 (52H)	84 (54H)	Motor Current	0 - 255%	Read Only
C56	83 (53H)	85 (55H)	Drive Load	0 - 255%	Read Only
C59		86 (56H)	PI Actual Feedback	c86 - c87	Read Only
C70		89 (59H)	PI Proportional Gain	0 - 999 (0 - 99.9%)	5.0%
C71		90 (5AH)	PI Integral Gain	0 - 999 (0 - 99.9 sec)	0.0 sec
C90	86 (56H)	92 (5CH)	Input Voltage Selection	0 Auto 1 Low 2 High	0
C94	88 (58H)	94 (5EH)	User Password	0 - 999	0
C99	89 (59H)	95 (5FH)	Software Version	Read 4 words (format 'SMD 1.51')	Read Only
c01		96 (60H)	Accel Rate 2	0 - 9990 (0.0 - 999 sec)	5.0 sec
c03		97 (61H)	Decel Rate 2	0 - 9990 (0.0 - 999 sec)	5.0 sec
c06	90 (5AH)	98 (62H)	Holding Time - Auto DC Injection Brake	0 - 9990 (0.0 - 999 sec)	0.0 sec
c08	91 (5BH)	99 (63H)	Analog Output Scaling	10 - 9990 (1.0 - 999)	100.0
c11	92 (5CH)	100 (64H)	Configuration Analog Output (62)	0 None 1 Output frequency 0 - 10V 2 Output frequency 2 - 10V 3 Load 0 - 10V 4 Load 2- 10V 5 Dynamic Braking	0
c17	93 (5DH)	101 (65H)	Configuration Digital Output (A1)	0 Ready 1 Fault 2 Motor is running 3 Motor is running - CW rotation 4 Motor is running - CCW rotation 5 Output frequency = 0Hz 6 Frequency setpoint reached 7 Threshold (C17) exceeded 8 Current limit reached <b>9 Feedback within min/max alarm range</b> <b>10 Feedback outside min/max alarm range</b>	0
c20	94 (5EH)	102 (66H)	I <sup>2</sup> T Switch-Off	30 - 100%	100%

1 = The drive's programming code number; 2 = Selections in **bold** are for *smd* models with PV507 only.

# Drive Control & Communication

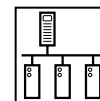

Parameter No. <sup>1</sup>	smd Register # (hexadecimal representation)		Parameter Name	Range of Adjustment <sup>2</sup> Modbus value (decimal value)	Factory Default
	PV400	PV507			
c25	95 (5FH)	103 (67H)	LECOM Baud Rate	0 9600 bps (9600, 8, N, 2 if C01 = 8...11) 1 4800 bps (9600, 8, N, 1 if C01 = 8...11) 2 2400 bps (9600, 8, E, 1 if C01 = 8...11) 3 1200 bps (9600, 8, O, 1 if C01 = 8...11)	0
c38		105 (69H)	PI Actual Setpoint	c86 - c87	Read Only
c40	97 (61H)	106 (6AH)	Freq. Setpoint Command	0 - 2400 (0.0 - 240 Hz)	0.0 Hz
c42	98 (62H)	107 (6BH)	Start Condition	0 Start after LOW-HIGH change at 28 1 Auto Start if 28 = HIGH	1
c60		109 (6DH)	Mode Select for c61	0 Monitor Only 1 Monitor and Edit	0
c61	100 (64H)	110 (6EH)	Present Fault	Status / Error Message (refer to Note 5)	Read Only
c62	101 (65H)	111 (6FH)	Last Fault	Error Message (refer to Note 5)	Read Only
c63	102 (66H)	112 (70H)	Last but one Fault	Error Message (refer to Note 5)	Read Only
c70	103 (67H)	113 (71H)	Configuration TRIP Reset	0 TRIP reset by LOW-HIGH signal at 28 or mains switching or LOW-HIGH signal at digital input "TRIP reset" 1 Auto TRIP reset	0
c71	104 (68H)	114 (72H)	Auto TRIP Reset Delay	0 - 600 (0.0 - 60.0 sec)	0.0 sec
c78	105 (69H)	115 (73H)	Operating Time Counter		Read Only
c79	106 (6AH)	116 (74H)	Mains Conn Time Counter		Read Only
c81		117 (75H)	PI Setpoint	c86 - c87	0.0
c82		118 (76H)	S-Ramp Integral Time	0 - 500 (0.0 - 50.0 sec)	0.0 sec
c86		119 (77H)	PI Min Feedback	0 - 9990 (0.0 - 999.0)	0.0
c87		120 (78H)	PI Max Feedback	0 - 9990 (0.0 - 999.0)	100.0
d25		123 (7BH)	PI Setpoint Accel/Decel	0 - 9990 (0.0 - 999.0 sec)	5.0 sec
d38		124 (7CH)	PI Enable	0 PI Disabled 1 PI Enabled - Normal Acting 2 PI Enabled - Reverse Acting	0
d46		125 (7DH)	PI Min Alarm	0 - 9990 (0.0 - 999.0)	0.0
d47		126 (7EH)	PI Max Alarm	0 - 9990 (0.0 - 999.0)	0.0
n20	113 (71H)	131 (83H)	LECOM Power-Up State	0 Quick Stop 1 Inhibit	0
n22	114 (72H)	132 (84H)	Serial Timeout Action	0 Not Active 1 Controller Inhibit 2 Quick Stop 3 Trip Fault "FC3"	0
n23	115 (73H)	133 (85H)	Serial Fault Time	50 - 65535 ms	50 ms

1 = The drive's programming code number; 2 = Selections in **bold** are for **smd** models with PV507 only.

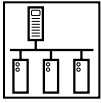

## Drive Control & Communication



### NOTE 5 - *smd* - Fault History

Parameters c61 (Present Fault), c62 (Last Fault) and c63 (Last but one Fault) provide the Fault History for the *smd* drive. Table 18 lists the fault codes.

Table 18: Fault Codes - c61, c62 & c63

Code	Fault Description	Display
0	NO FAULT	
1	OUTPUT (TRANSISTOR) FAULT	OC1
2	HIGH DRIVE TEMPERATURE	OH
3	HIGH DC BUS VOLTAGE	OU
4	LOW DC BUS VOLTAGE	LU
5	THERMAL OVERLOAD	OC6
6	CONTROL FAULT	CF
7	EXTERNAL FAULT	EEr
8	SERIAL COMMUNICATION FAILURE	FC5
9	START ERROR	LC
10	INTERNAL FAULT 1 (EPM)	F1
11	INTERNAL FAULT 2	F2
12	INTERNAL FAULT 3	F3
13	INTERNAL FAULT 4	F4
14	INTERNAL FAULT 5	F5
15	INTERNAL FAULT 6	F6
16	INTERNAL FAULT 7	F7
17	INTERNAL FAULT 8	F8
18	INTERNAL FAULT 9	F9
19	INTERNAL FAULT o	Fo
20	SINGLE PHASE FAULT	SF
21	INCOMPATIBILITY FAULT	cF
22	DYNAMIC BRAKE OVERHEATED	dF
23	REMOTE KEYPAD FAULT	JF
24	COMMUNICATION FAULT	FC3
25	EARTH FAULT	“OC2”
26	CONFIGURATION FAULT	“CFG”

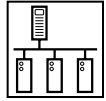

## 7 Quick Start Instructions

Follow these Quick Start instructions to use Modbus Communications for basic network control of an **smd** drive. These instructions are for basic start, stop, direction and speed control of the **smd** drive. To download the **smd** manual visit the Lenze-AC Tech Technical Library at <http://www.lenze-actech.com>.

### 7.1 Initial Settings

These instructions are for basic start, stop direction and speed control of the smd drive using Modbus communication.

1. Set Drive Parameter C01 to 11.
2. Set Drive Parameter C09 to the desired network address that the Modbus master will poll. Valid Modbus addresses are 1-247.

**TIP** - Avoid using address 1. Most Modbus devices ship with a default address of 1. As duplicate addressing on a Modbus network is not allowed, this can lead to conflicts when replacing and commissioning nodes. To avoid this it is recommended that you do not set the slave address to 1.

3. The Modbus master needs to be set to use 9600 baud. No other baud rates are supported by the SMD drive.
4. The SMD series drive has the provision for a watchdog timer to monitor network communications to the drive. The drive's timeout behavior is set using Parameter n22 and the timeout period is set using Parameter n23 as shown in Table 19.

Table 19: Watchdog Timer

Code		Possible Settings		Important
No.	Name	Lenze	Selection	
n22	Serial Timeout Action	0	0 Not Active 1 Controller Inhibit 2 Quick Stop 3 Trip Fault "FC3"	Selects controller reaction to serial timeout
n23	Serial Fault Time	50	50 - 65535 ms	Sets the serial timeout length

Set n22 and n23 as appropriate for the application:

5. The drive needs to have its network data formatting set the same as the Modbus master.
  - a. If the Modbus master is set to use 8 data bits, no parity and two stop bits, set c25 to 0.
  - b. If the Modbus master is set to use 8 data bits, no parity and one stop bit, set c25 to 1.
  - c. If the Modbus master is set to use 8 data bits, even parity and one stop bit, set c25 to 2.
  - d. If the Modbus master is set to use 8 data bits, odd parity and one stop bit, set c25 to 3.

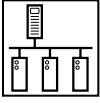

## Drive Control & Communication

### 7.2 Drive Control

1. Please be advised that while the drive is under network control the local STOP circuit is always enabled. Input 28 needs to be asserted in order for the drive to start. If you will not be using start/stop simply jumper TB28 input to TB20.
2. Use either Modbus function code 16 with a length of 1 or Modbus function code 06 to perform any writes to the drive.
3. Unlocking the Drive.

The first write necessary to the drive to perform any function (start, change speed, change a parameter, etc) needs to be an unlock.

If you want to both control the drive and alter any programming parameters then write the drive's programming password to Modbus register 40049. The default password for the SMD drive is 0.

You should only need to send the unlock command once after power up. As long as the communications do not timeout you should not need to write another unlock to the drive before writing any other function.

4. Setting the Drive to Network Speed reference:

In order for the drive to respond to speed commands written to the keypad speed register the drive must be put into manual mode. To do this write a value of 100H to Modbus register 40002 (the drive's control register).

### 7.3 Basic Drive Commands

The following are the basic drive commands. ONLY ONE OF THESE CAN BE DONE AT A TIME:

1. To STOP the drive using COAST TO STOP, write a value of 0004hex to Modbus register 40002 (AC Tech register 1).
2. To Start the drive write a value of 0008hex to Modbus register 40002.
3. To Set Reverse direction write a value of 0040hex to Modbus register 40002.
4. To Set Forward direction (the drive powers up with forward direction already selected) write a value of 0080hex to Modbus register 40002.
5. If you want the network to control speed of the drive, write the speed to the Serial Speed Command Register, Modbus register 40041 (AC Tech register 40). Speed is written in 0.1Hz (so 412 would be 41.2 Hz). In this mode the drive's initial speed reference on power up will be the last speed written to the drive.

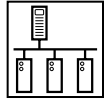

## 7.4 Basic Drive Status

AC Tech register 24 is a 6 word entity containing the drive's status information. To read the entire status block use Modbus function code 3 with a length of 6 to read starting at Modbus register number 40025. The low byte of the third word in this block of data contains the operational status. If this is the only data you want you can use Modbus function code 3 with a length of 1 to read register 40027.

The value of that low byte of data corresponds to the following operational states:

Table 20: Operational Status

Bit	Parameter
0	FAULT LOCKOUT
1	FAULT
2	START PENDING
3	STOP
4	DC BRAKE
5	RUN AT 0Hz
6	RUN
7	ACCEL
8	DECEL
9	CURRENT LIMIT
10	DECEL OVERRIDE
11	LOWER TRANSISTORS SWITCHING ON
12	OFF
13	INHIBIT

**AC Technology Corporation**

630 Douglas Street • Uxbridge MA 01569 • USA  
Sales: 800-217-9100 • Service: 508-278-9100  
[www.lenze-actech.com](http://www.lenze-actech.com)

RG-SDMOD-e3